

# Assembly, installation and maintenance manual

Montage-, Aufbau- und Wartungsanleitung • Assemblage, manuel de montage et d'entretien • Montaje, instalación y mantenimiento • Manuale di montaggio, installazione e manutenzione • Monterings- og vedlikeholdsmanual • Monterings-, installations- och underhållsmanual • Kokoamis-, asennus- ja huolto-ohje • Vejledning for montering og vedligehold • Handleiding voor montage, installatie en onderhoud • Manual de montagem, instalação e manutenção • Návod k montáži, instalaci a údržbě • Instrukcja montażu, instalacji i konserwacji • Surinkimo, montavimo ir priežiūros vadovas • Montāžas, uzstādīšanas un apkopes rokasgrāmata • Руководство по сборке и обслуживанию • Montaaži-, paigaldus- ja säilitamise juhend



## Pavilion **PA44-4254-1**

<p><b>Factory inspection by</b> • Werkskontrolle durch • Contrôle à partir de l'usine par • Inspector de fábrica • Collaudato da • Fabrikkkontroll utført av • Fabriksbesiktigat av • Tehtaan tarkastaja • Fabriks Kontrol udført af • Fabriekscontrole door • Inspeção de fábrica, por: • Zkontrolováno ve výrobním závodě • Kontrola fabryczna do • Apžiūrą gamykloje atliko • Rūpnīcas pārbaudi veicis • Заводской контроль • Tehase kontroll teostatud:</p> <p>.....</p>	<p><b>Date</b> • Datum • Date • Fecha • Data • Dato • Datum • Päiväys • Dato • Datum • Data • Datum • Data • Datums • Data • Дата • Kuupäev:</p>
	<p><b>Pack number</b> • Pack Nr. • Packet n° • Bulto N° • Pacco N. • Serienr • Produktionsnummer • Pakettinro • Pakke nr. • Pak nr. • Número de embalagem • Číslo balení • Numer opakowania • Pakuotės numeris • Iepakojuma numurs • Упаковочный номер • Pakinumber:</p>



[www.palmako.ee/information-hub](http://www.palmako.ee/information-hub)

**English:** Before installing and using the product, please read the instructions and warranty terms at [www.palmako.ee/information-hub](http://www.palmako.ee/information-hub) to guarantee proper installation and long-lasting performance.

**Deutsch:** Wichtig! Bitte vor Aufbau und Nutzung des Produkts unbedingt die detaillierte Montageanleitung sowie die Garantiebedingungen unter [www.palmako.ee/information-hub](http://www.palmako.ee/information-hub) lesen, um eine fachgerechte Montage und eine lange Funktionssicherheit zu gewährleisten.

**Français:** Avant d'installer et d'utiliser le produit, veuillez lire les instructions et les conditions de garantie sur [www.palmako.ee/information-hub](http://www.palmako.ee/information-hub) afin de garantir une installation correcte et la longévité du produit.

**Español:** Antes de instalar y utilizar el producto, lea las instrucciones y las condiciones de garantía en [www.palmako.ee/information-hub](http://www.palmako.ee/information-hub) para asegurar una instalación correcta y una larga vida útil del producto.

**Italiano:** Prima di installare e utilizzare il prodotto, leggere le istruzioni e le condizioni di garanzia su [www.palmako.ee/information-hub](http://www.palmako.ee/information-hub) per garantire una corretta installazione e prestazioni durature.

**Norsk:** Før montering og bruk av produktet, vennligst les monteringsanvisningene og garantivilkårene på [www.palmako.ee/information-hub](http://www.palmako.ee/information-hub) for å sikre korrekt montering og fremtidig holdbarhet.

**Svenska:** Innan du installerar och använder produkten, vänligen läs instruktionerna och garantivillkoren på [www.palmako.ee/information-hub](http://www.palmako.ee/information-hub) för att säkerställa korrekt installation och produktens långvariga hållbarhet

**Suomi:** Ennen tuotteen asentamista ja käyttämistä, lue ohjeet ja takuehdot osoitteessa [www.palmako.ee/information-hub](http://www.palmako.ee/information-hub) varmistaaksesi oikean asennuksen ja pitkäkestoisen toiminnan.

**Русский:** Перед установкой и использованием изделия ознакомьтесь с инструкцией и условиями гарантии на сайте [www.palmako.ee/information-hub](http://www.palmako.ee/information-hub), чтобы гарантировать правильную установку и долговечность изделия.

**Eesti:** Enne toote paigaldamist ja kasutuselevõttu lugege palun juhiseid ja garantiitingimusi aadressil [www.palmako.ee/information-hub](http://www.palmako.ee/information-hub), et tagada nõuetekohane paigaldus ja toote pikk eluiga.

**Dansk (Oversat af AI):** Læs venligst instruktionerne og garantibetingelserne på [www.palmako.ee/information-hub](http://www.palmako.ee/information-hub), før du installerer og bruger produktet, for at garantere korrekt installation og langvarig ydeevne.

**Dutch (Vertaald door AI):** Lees vóór de installatie en het gebruik van het product de instructies en garantievoorwaarden op [www.palmako.ee/information-hub](http://www.palmako.ee/information-hub) om een correcte installatie en langdurige werking te garanderen

**Português (Traduzido por IA):** Antes de instalar e utilizar o produto, leia as instruções e os termos de garantia em [www.palmako.ee/information-hub](http://www.palmako.ee/information-hub) para garantir uma instalação adequada e um desempenho duradouro.









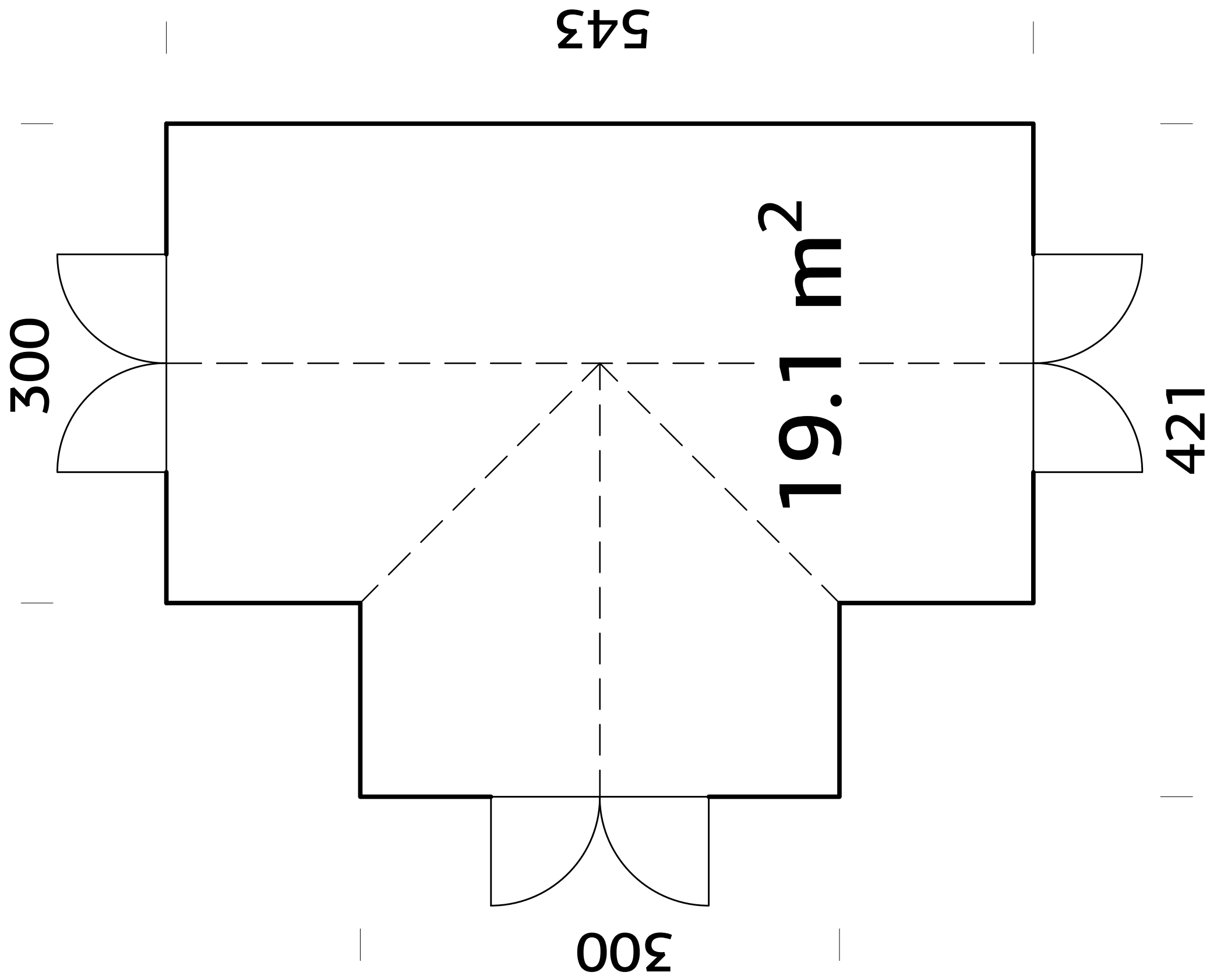

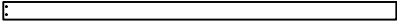



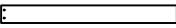

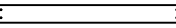









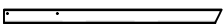



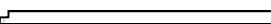

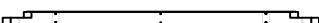







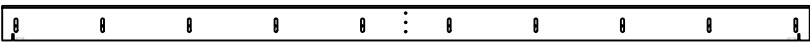

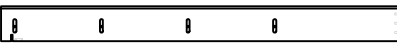

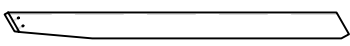

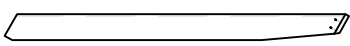

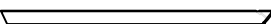

**Čeština (Přeloženo umělou inteligencí):** Před instalací a použitím produktu si prosím přečtěte pokyny a záruční podmínky na [www.palmako.ee/information-hub](http://www.palmako.ee/information-hub), abyste zaručili správnou instalaci a dlouhodobý výkon.

**Polski (Przetłumaczone przez AI):** Przed zainstalowaniem i użyciem produktu należy przeczytać instrukcję oraz warunki gwarancji dostępne na stronie [www.palmako.ee/information-hub](http://www.palmako.ee/information-hub), co pozwoli zagwarantować prawidłową instalację i długotrwałą wydajność.









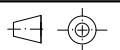



























**Latviešu (Mākslīgā intelekta tulkojums):** Pirms produkta uzstādīšanas un lietošanas, lūdzu, izlasiet instrukcijas un garantijas noteikumus vietnē [www.palmako.ee/information-hub](http://www.palmako.ee/information-hub), lai garantētu pareizu uzstādīšanu un ilgstošu darbību.







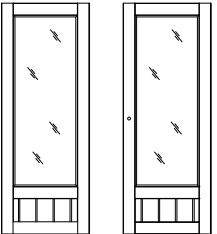
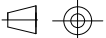

**Lietuviškai (Išvertė DI):** Prieš montuodami ir naudodami gaminį, perskaitykite instrukcijas ir garantijos sąlygas adresu [www.palmako.ee/information-hub](http://www.palmako.ee/information-hub), kad užtikrintumėte tinkamą montavimą ir ilgalaikį veikimą.

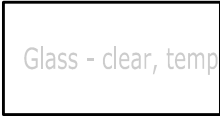





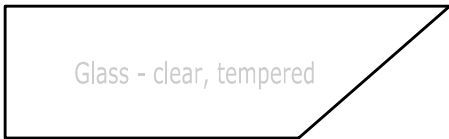
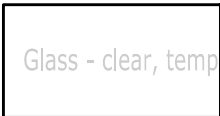





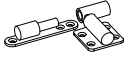
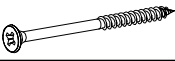
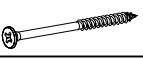







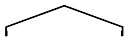
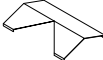



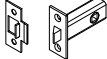

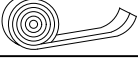
Pos	SPECIFICATION-STÜCKLISTE-NOMENCLATURE-ELEMENTI	Pcs	Profile (mm)	Length (mm)
<b>Emilia T-shape</b>				
1	Foundation beam 	2	 45 × 120	2713
2	Foundation beam 	3	 45 × 120	2910
3	Foundation beam 	2	 45 × 120	1213
4	Foundation beam 	2	 45 × 120	1258
42	Foundation beam 	1	 45 × 120	540
5	Post 	1	 120 × 120	1647
6	Post 	1	 120 × 120	1647
7	Corner Left 	3	 44 × 95	1502
8	Corner Right 	3	 44 × 95	1502
9	Frame 	3	 44 × 95	1893
10	Frame 	3	 44 × 95	1893
11	Frame 	3	 44 × 95	2182
12	Ridge support 	3	 44 × 91	661
13	Rafter Left 	3	 44 × 95	1879
14	Rafter Right 	3	 44 × 95	1879
15	Ridge LONG 	1	 80 × 240	5574
16	Ridge SHORT 	1	 80 × 240	2747
17	Valley rafter 	1	 56 × 180	2376
18	Valley rafter 	1	 56 × 180	2376
19	Frame Side 	12	 44 × 95	1562
20	Rafter 	12	 44 × 95	1879
21	Valley jack 	2	 44 × 95	1877
22	Valley jack 	2	 44 × 95	1877
23	Valley jack 	2	 44 × 95	1155
24	Valley jack 	2	 44 × 95	1155

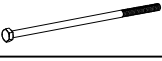
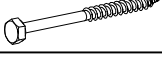

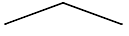
Pos	SPECIFICATION-STÜCKLISTE-NOMENCLATURE-ELEMENTI Emilia T-Shape	Pcs	Profile (mm)	Length (mm)
25	Frame 	4	 45 × 45	554
26	Corner 	34	 15 × 173	360
27	Rafter connection 	1	 45 × 12	3035
28	Rafter connection 	6	 45 × 12	1236
29	Slat - side 	18	 45 × 12	1502
30	Slat - roof 	18	 45 × 12	1910
31	Slat - roof 	2	 45 × 12	1829
32	Slat - roof 	2	 45 × 12	1829
33	Slat - roof 	2	 45 × 12	1059
34	Slat - roof 	2	 45 × 12	1059
35	Slat - side 	3	 45 × 12	1894
37	Slat - side 	12	 45 × 12	1827
38	Slat - side 	6	 45 × 12	1383
39	Slat - side 	6	 45 × 12	1814
40	Slat - side 	6	 45 × 12	1478
41	Slat - side 	2	 45 × 12	1502
EL1		657 x 390 x 45		6
EL2		1144 x 390 x 45		2
EL3		1144 x 390 x 45		2
EL4		2968 x 390 x 45		1
EL5		2392 x 390 x 45		1
KUL-145 KUL-145-2		696 x 1818 x 40		3+3
	Object name Emilia T-Shape	Page 2 / 4		

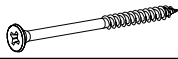
Pos.	Description	Measures (mm)	Pcs
401	 Glass - clear, tempered	578 x 1895 x 4	11
402	 Glass - clear, tempered	578 x 1115 x 4	13
403	 Glass - clear, tempered	578 x 1030 x 4	2
404	 Glass - clear, tempered	620 x 910 x 4	4
405	 Glass - clear, tempered	578 x 1895 x 4	4
406	 Glass - clear, tempered	578 x 979 x 4	2
407	 Glass - clear, tempered	700 x 1862 x 4	3
408	 Glass - clear, tempered	835 x 1074 x 4	4
409	 Glass - clear, tempered	578 x 1844 x 4	2
411	 Glass - clear, tempered	570 x 1115 x 4	4
412	 Glass - clear, tempered	680 x 1458 x 4	6

Pos.	Description	Measures (mm)	Pcs
F1	 QThermovent Thermovent 7kg	Thermovent 7kg	4
F2	 QUH55x60 55 x 60	55 x 60	8
F3	 QNU62x40x13 62 x 40 x 13	62 x 40 x 13	18
F4	 QHP15x57Zn 15 x 57	15 x 57	12
F5	 QKRPP6x120RVTX Ø 6 X 120	Ø 6 X 120	24
F6	 QKRPP5x90RVTX Ø 5 X 90	Ø 5 X 90	160
F7	 QKRYP5x55RVTX Ø 5 X 55	Ø 5 X 55	440
F8	 QKRYP4_2x38RVTX Ø 4.2 X 38	Ø 4.2 X 38	420
F9	 QKRPP3_5x40RVTX Ø 3.5 X 40	Ø 3.5 X 40	36
F10	 QKRPP4x25RVTX Ø 4 X 25	Ø 4 X 25	52
F11	 Polt M6 Ø 6 X 200	Ø 6 X 200	12
F12	 QMUUK6Zn M6	M6	14
F13	 QSE6x18Zn Ø 6 X 18	Ø 6 X 18	28
F14	 YHP200x2750MU 2750x 200 x 46	2750x 200 x 46	3
F15a	 YHP201x300MU 300 x 201 x 48	300 x 201 x 48	1
F15b	 YHP201x150MU 150 x 201 x 46	150 x 201 x 46	1
F16	 QHA150Zn 150 mm	150 mm	6
F17	 QUNAL 3 set		3 set
F18	 QRUAu 3 set		3 set
F19	 QLIKA 3 set		3 set
F20	 QTIB 0.8 m	0.8 m	1
F21	 QR35100Zn 35 x 100	35 x 100	6
F22	 QKRYP3x16Zn Ø 3 X 16	Ø 3 X 16	48
F23	 Polt M6 Ø 6 X 160	Ø 6 X 160	2
F24	 QKRKK12x200Zn Ø 12 X 200	Ø 12 X 200	5
F25	 QSE12x24Zn Ø 12 X 24	Ø 12 X 24	5
F26	 YNP90x2430MU 2430 x 90 x 23 mm	2430 x 90 x 23 mm	2
F28	 QNP150x100x40Zn 150 x 100 x 40	150 x 100 x 40	1
F29	 QKRPP6x180ZnTX Ø 6 X 180	Ø 6 X 180	8
F30	 QKRPP2_5x16kZn Ø 2,5 X 16	Ø 2,5 X 16	8

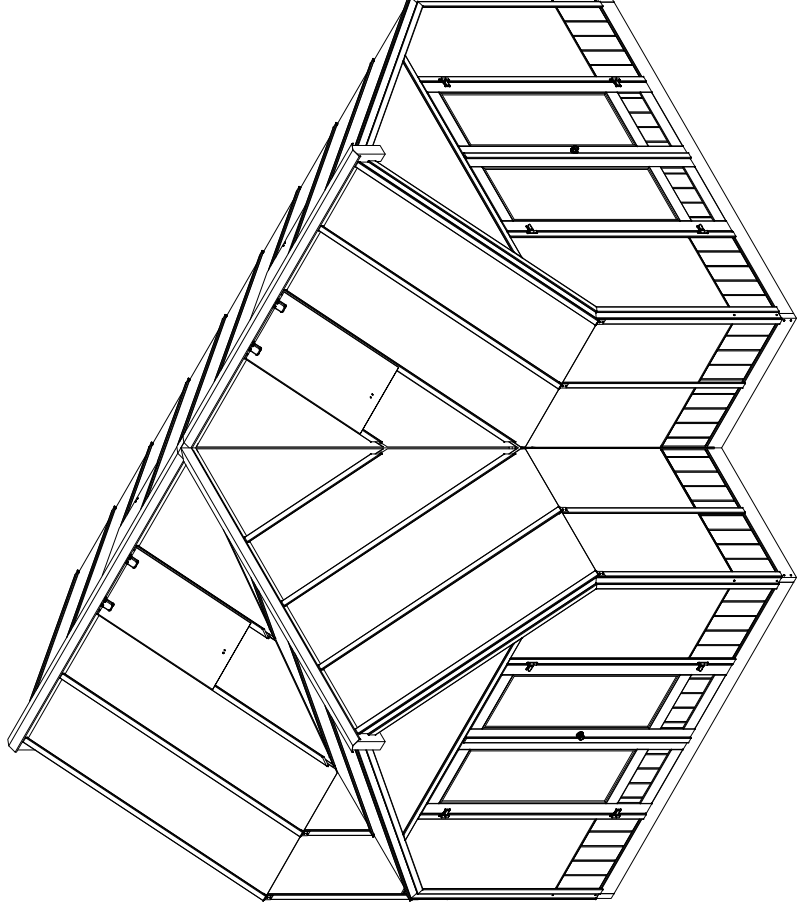
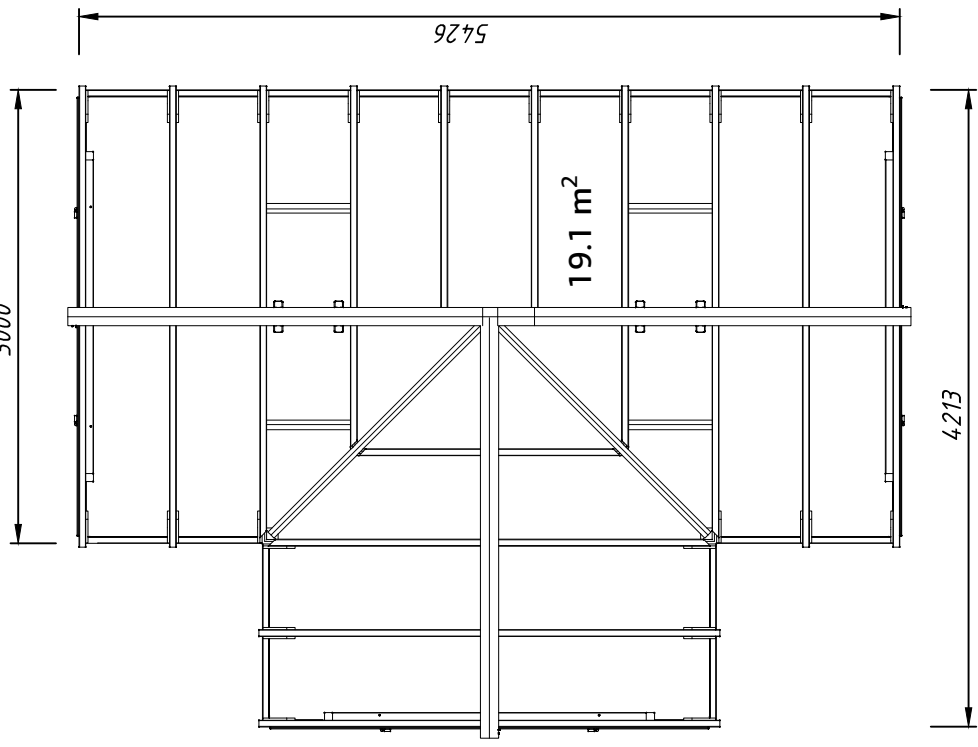
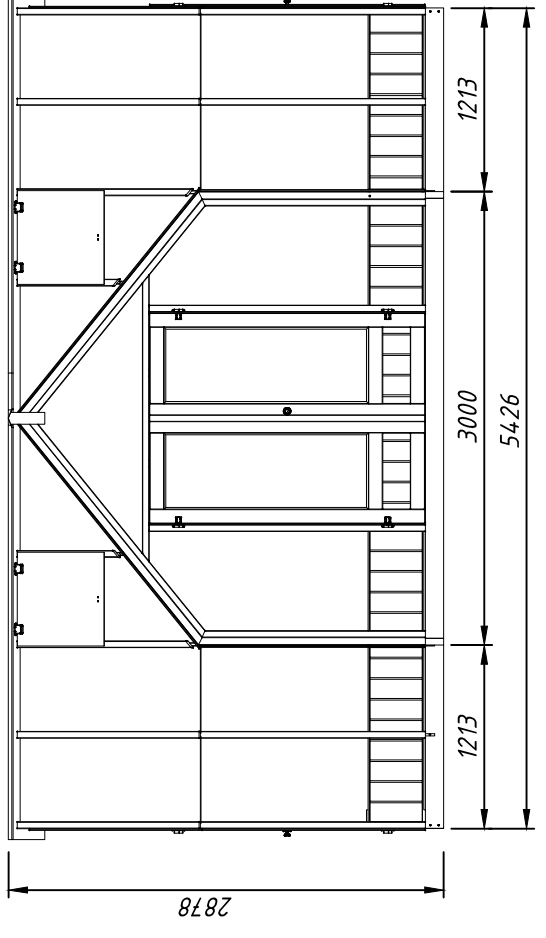
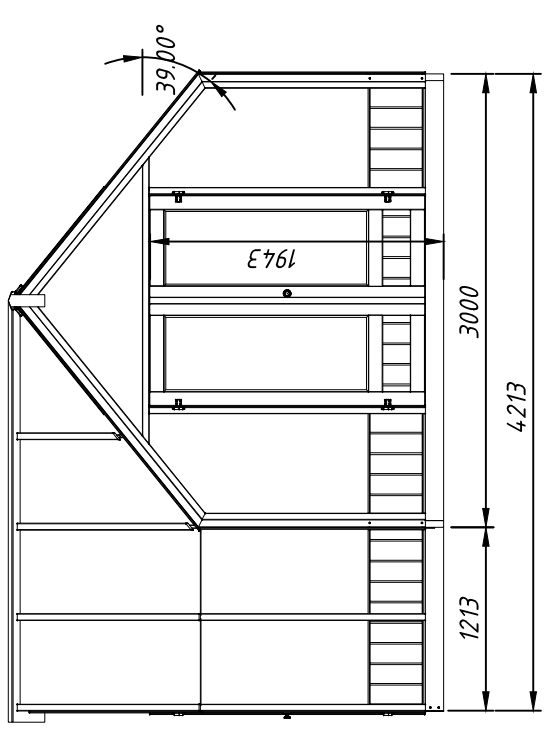

Scale 1:50  
Paper A3  
Page 1

Object name  
**EMILIA T-SHAPE**

Drawing

AS Palmako  
Näituse 25, Tartu, 50409, Estonia  
tel. +372 73 55 530  
fax. +372 73 55 544  
www.palmako.com

**Palmako**  
LEAKS GROUP

Elevations, plan

Drawn by 007  
Checked by  
Approved by

Date 10.09.2021  
Date  
Date

Scale 1:50  
Paper A3  
Page 1

Object name  
**EMILIA T-SHAPE**

Drawing

AS Palmako  
Näituse 25, Tartu, 50409, Estonia  
tel. +372 73 55 530  
fax. +372 73 55 544  
www.palmako.com

**Palmako**  
LEAKS GROUP

Elevations, plan

Drawn by 007  
Checked by  
Approved by

Date 10.09.2021  
Date  
Date

- det 1 - 1 pc
- det 2 - 3 pcs
- det 3 - 2 pcs
- det 4 - 2 pcs
- det 42 - 1 pc
- F5 - 16 pcs
- F6 - 8 pcs

1

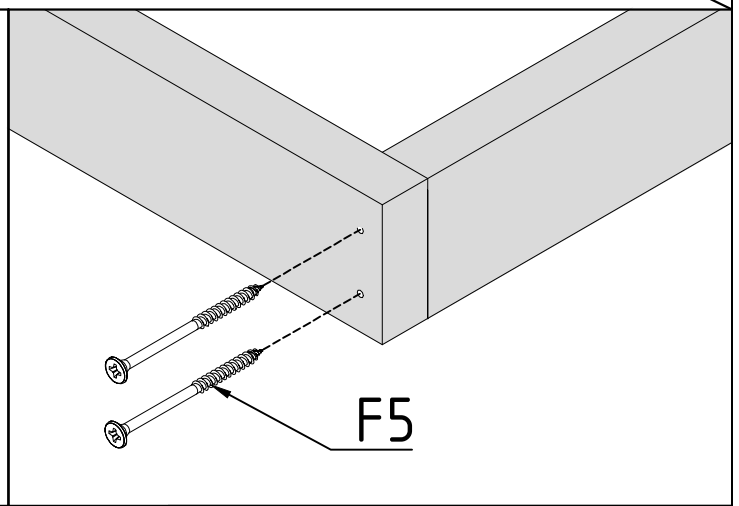
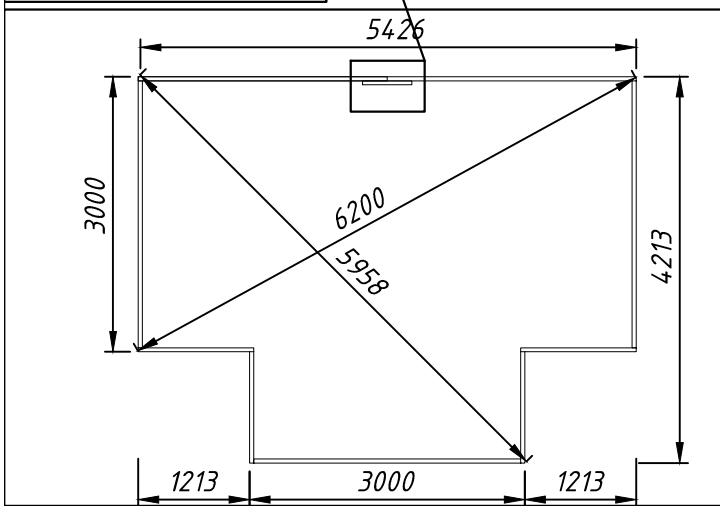
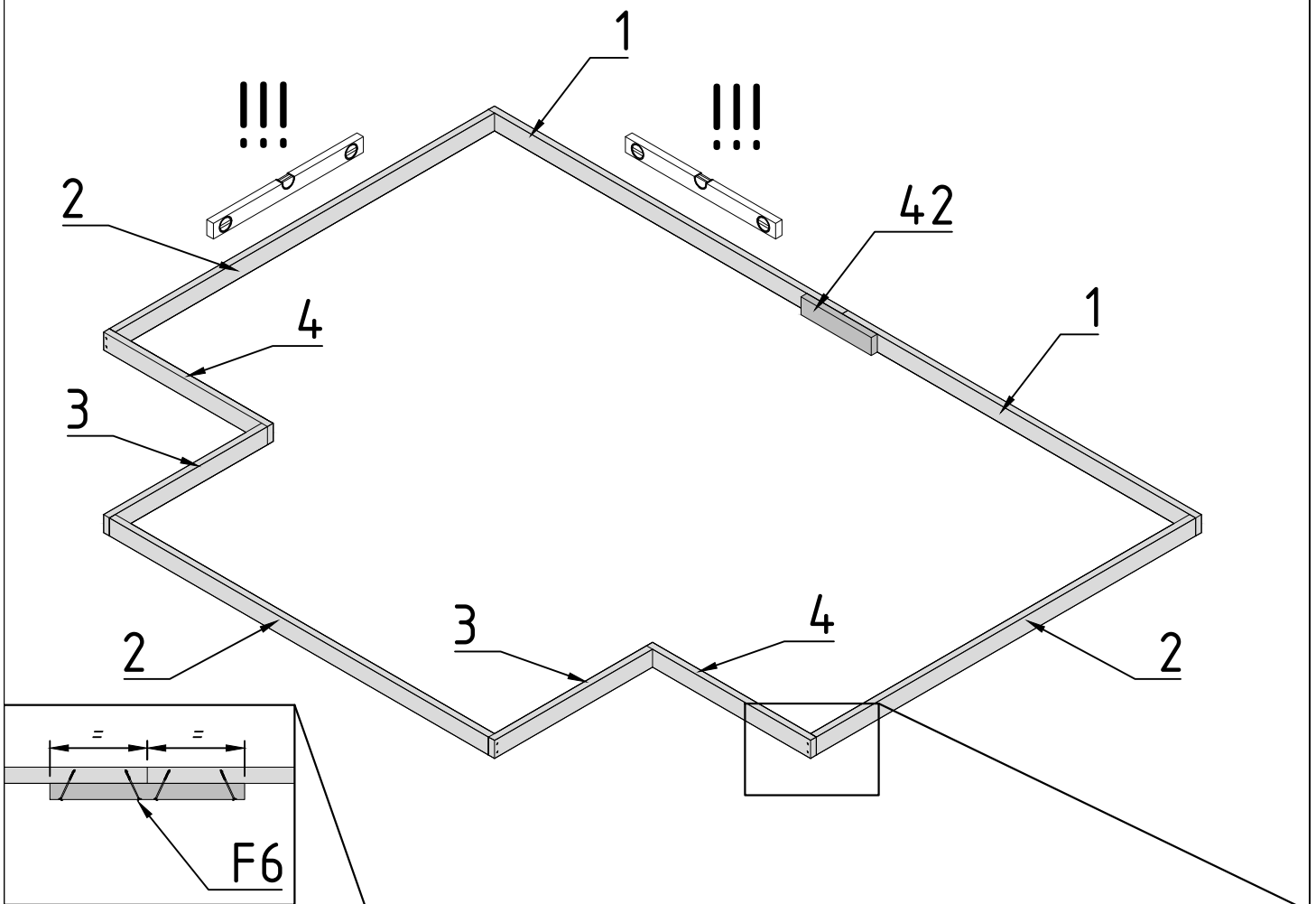

- EL 1 - 6 pcs
- EL 2 - 2 pcs
- EL 3 - 2 pcs
- EL 4 - 1 pcs
- EL 5 - 1 pcs
- F6 - 33 pcs

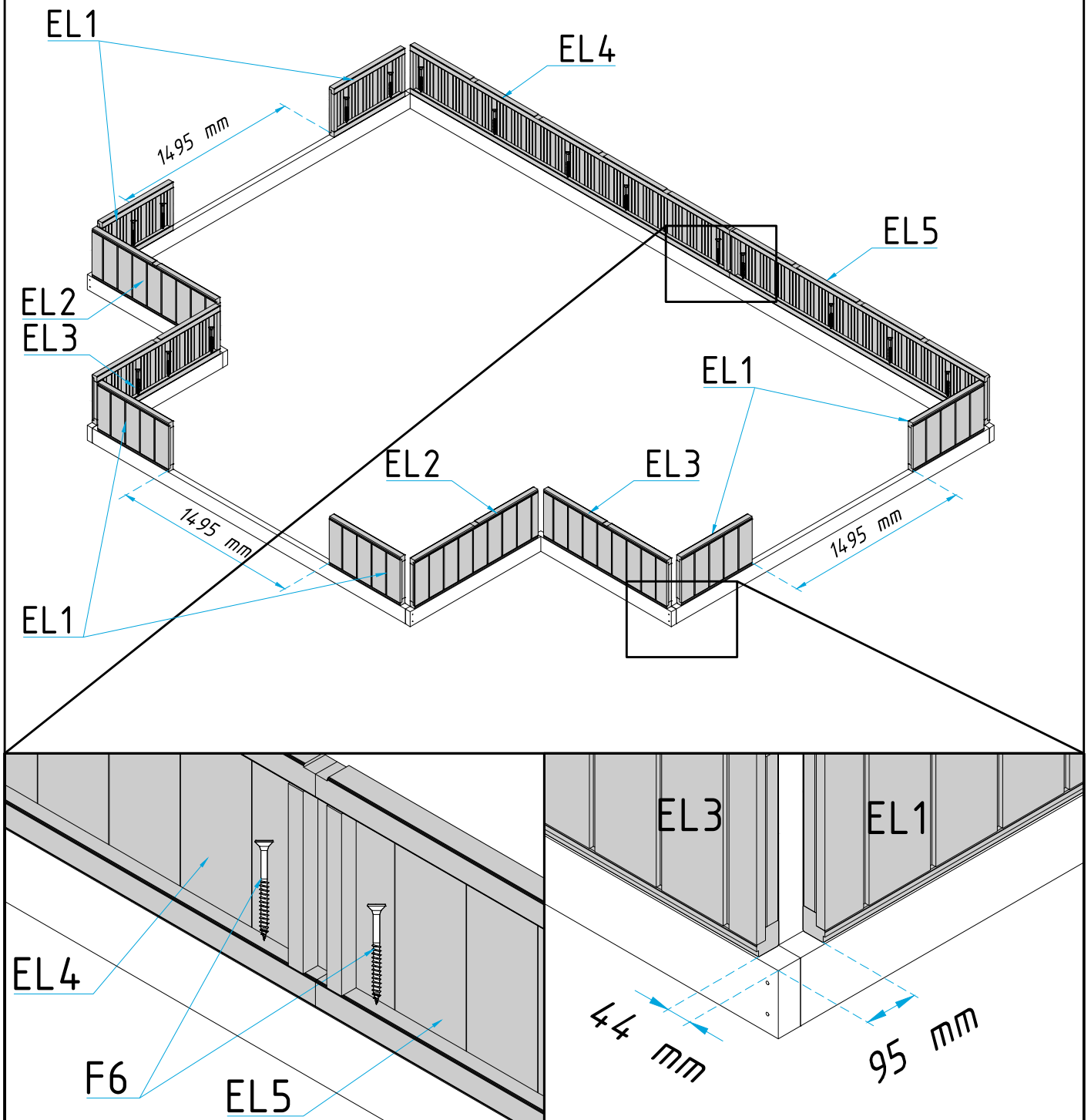

- det 5 - 1 pcs      F6 - 24 pcs
- det 6 - 1 pcs      F7 - 72 pcs
- det 7 - 3 pcs      F29 - 8 pcs
- det 8 - 3 pcs
- det 13 - 3 pcs
- det 14 - 3 pcs
- det 26 - 6 pcs

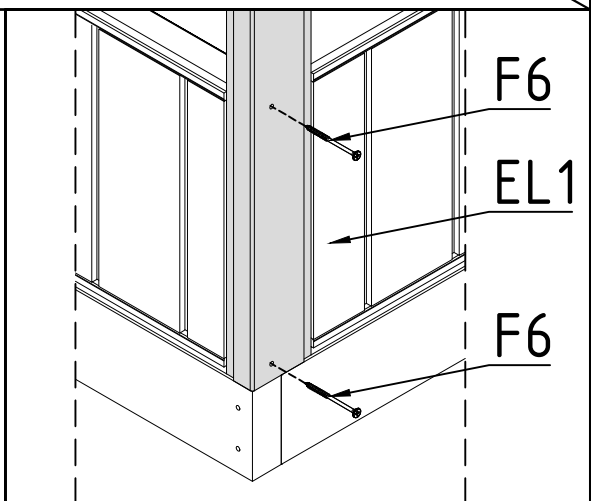
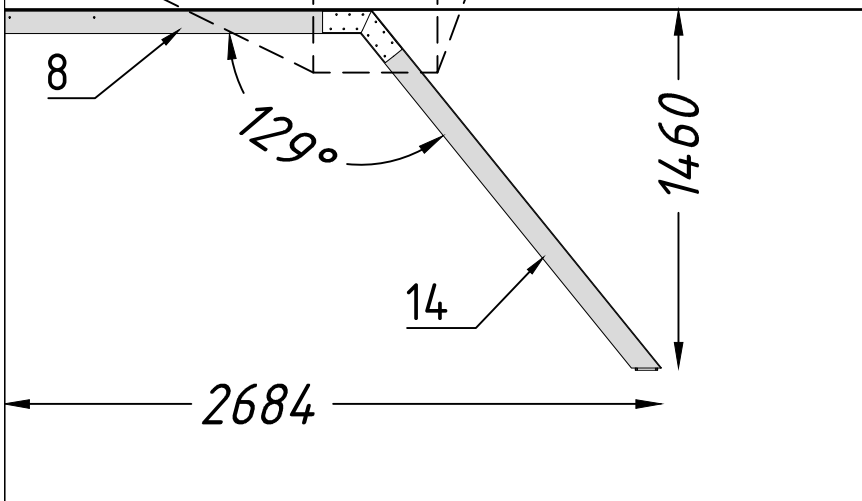
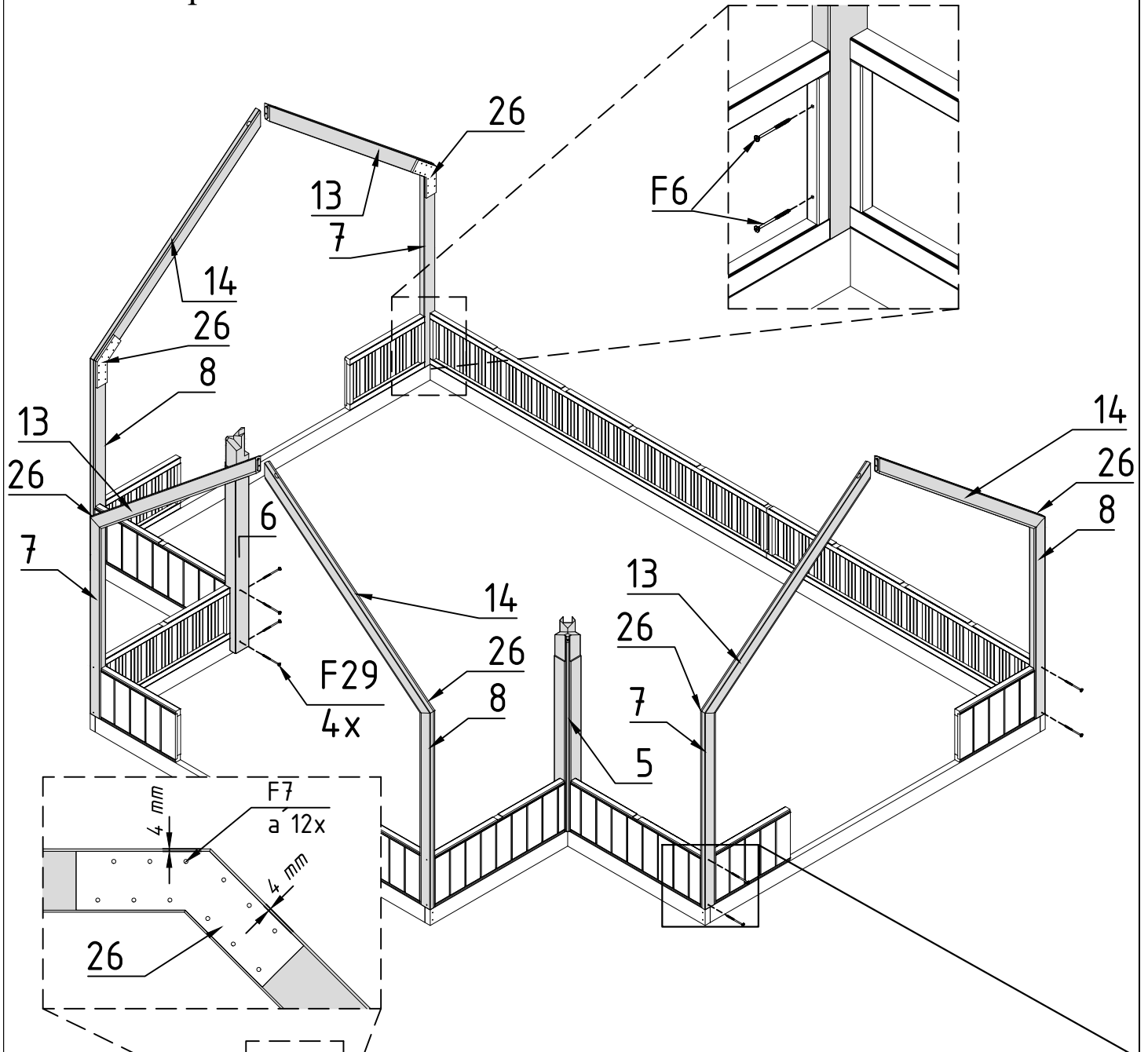

- det 9 - 3 pcs
- det 10 - 3 pcs
- det 11 - 3 pcs
- det 12 - 3 pcs
- F6 - 36 pcs

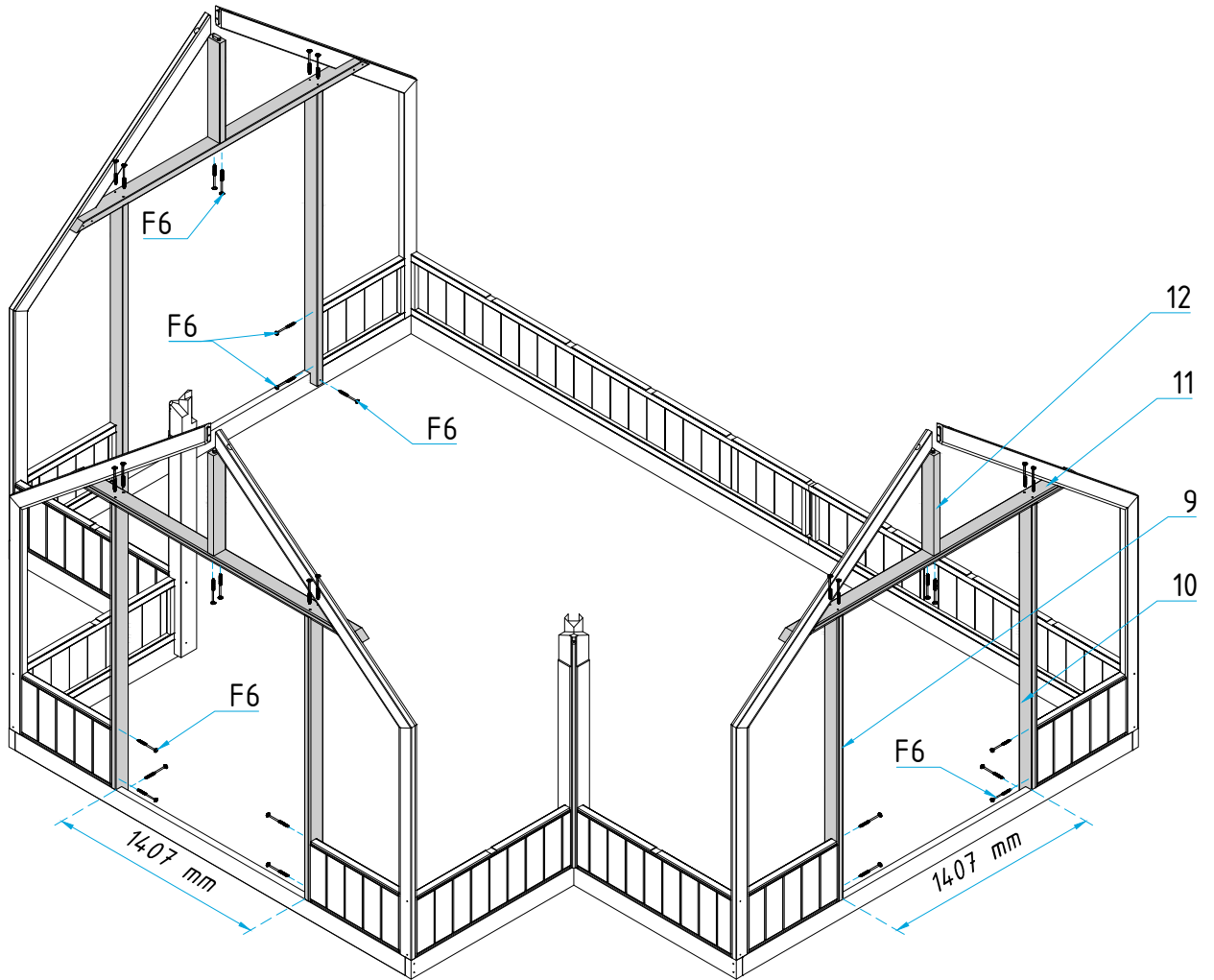

det 15 - 1 pcs  
 det 16 - 1 pcs  
 det 17 - 1 pcs  
 det 18 - 1 pcs

F5 - 8 pcs  
 F6 - 12 pcs  
 F9 - 12 pcs  
 F11 - 3 pcs  
 F12 - 3 pcs  
 F13 - 6 pcs  
 F24 - 5 pcs  
 F25 - 5 pcs  
 F28 - 1 pcs

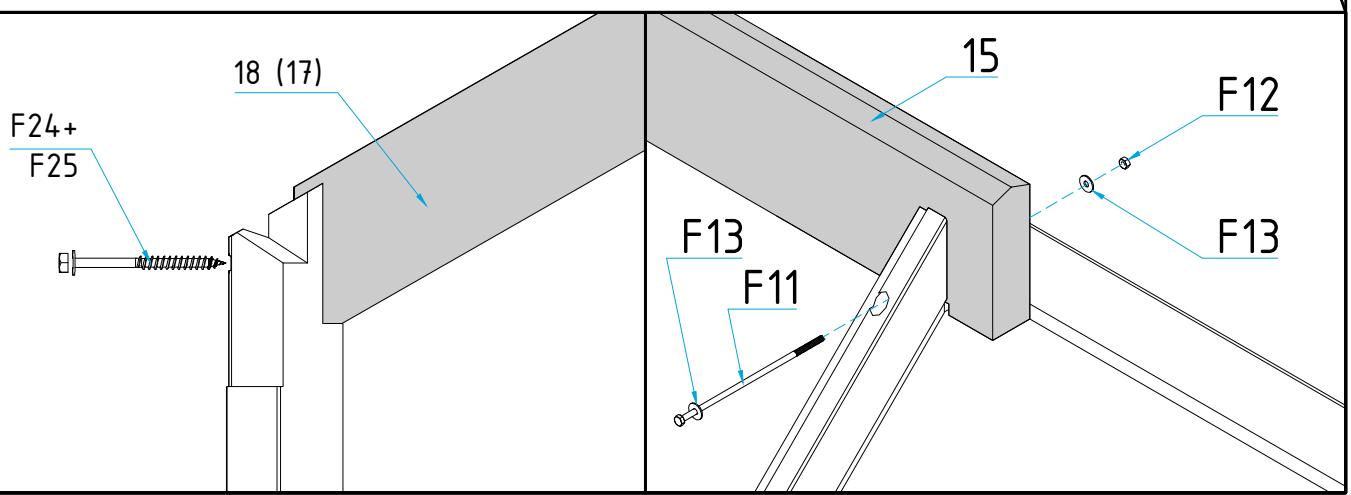
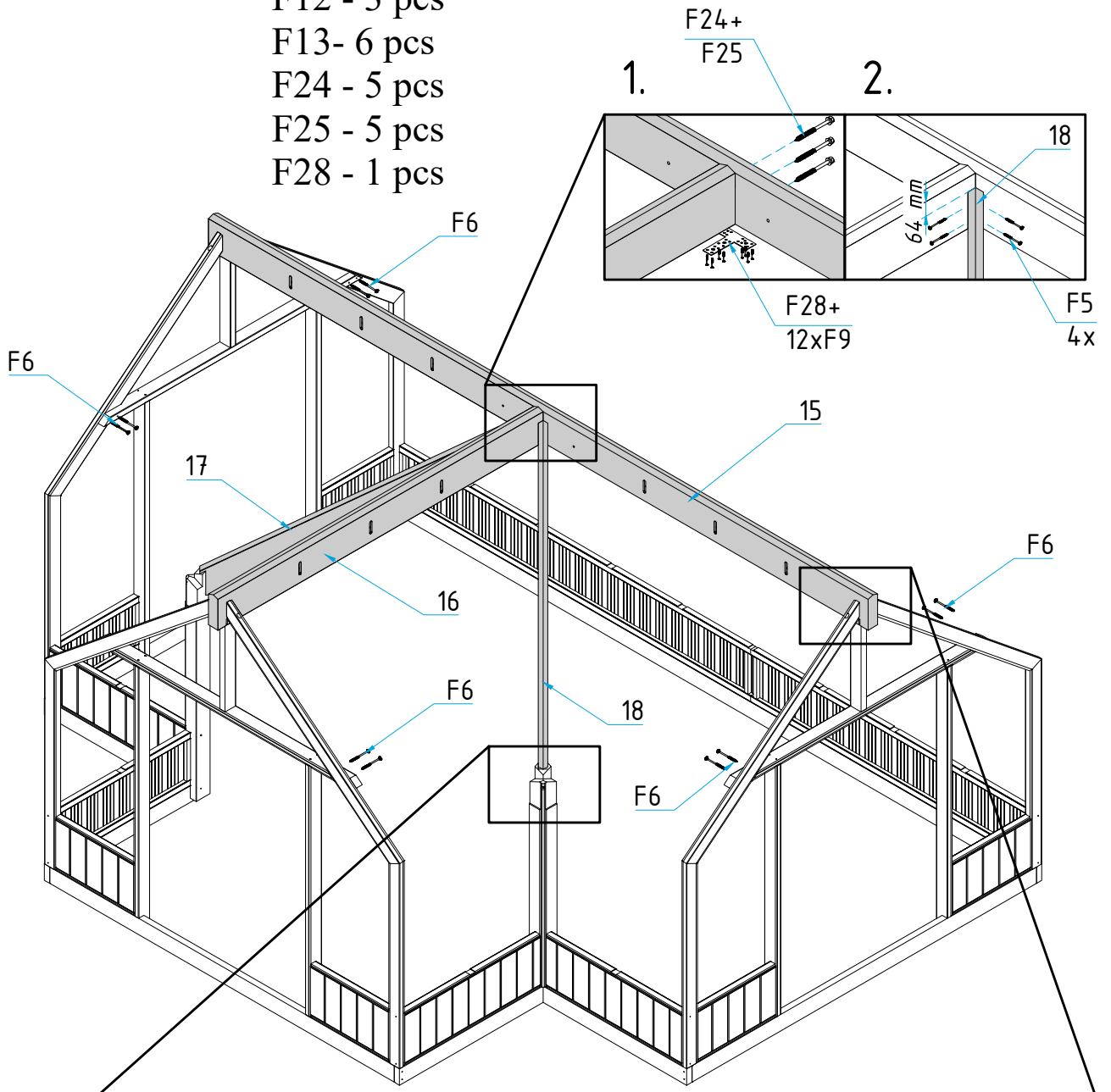

- det 19 - 12 pcs
- det 20 - 12 pcs
- det 21 - 2 pcs
- det 22 - 2 pcs
- det 23 - 2 pcs
- det 24 - 2 pcs
- det 25 - 4 pcs
- det 26 - 20 pcs
- det 27 - 1 pcs
- det 28 - 6 pcs

- F6 - 36 pcs
- F7- 360 pcs
- F11 - 9 pcs
- F12 - 11 pcs
- F13 - 22 pcs
- F23 - 2 pcs

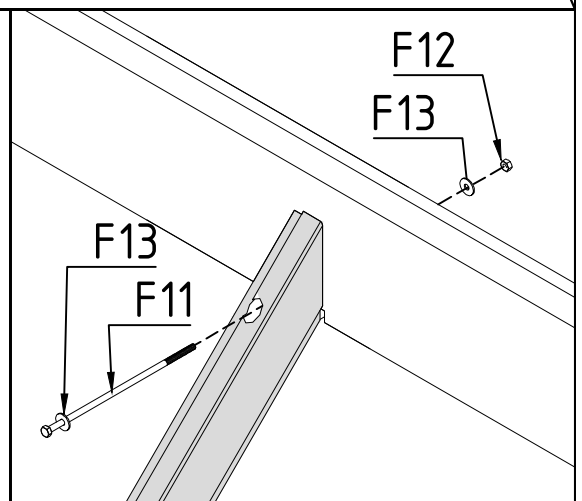
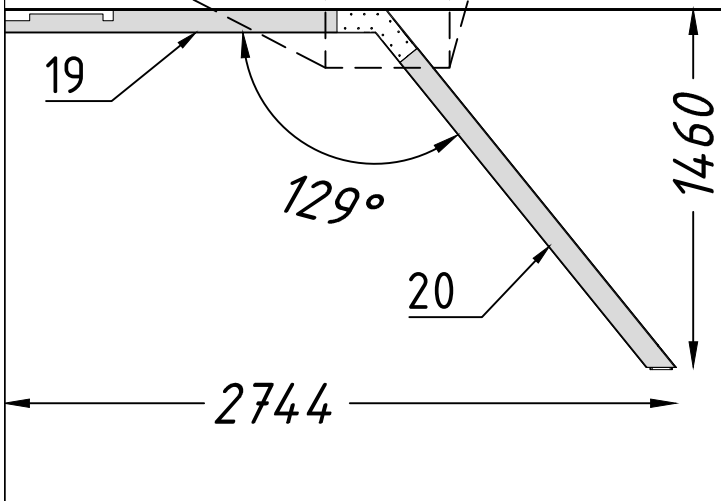
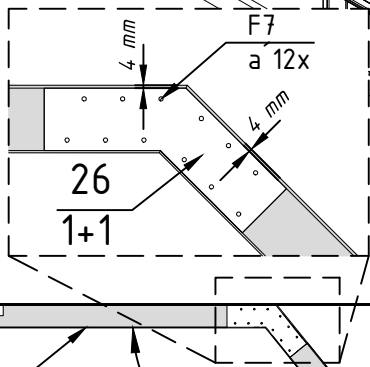
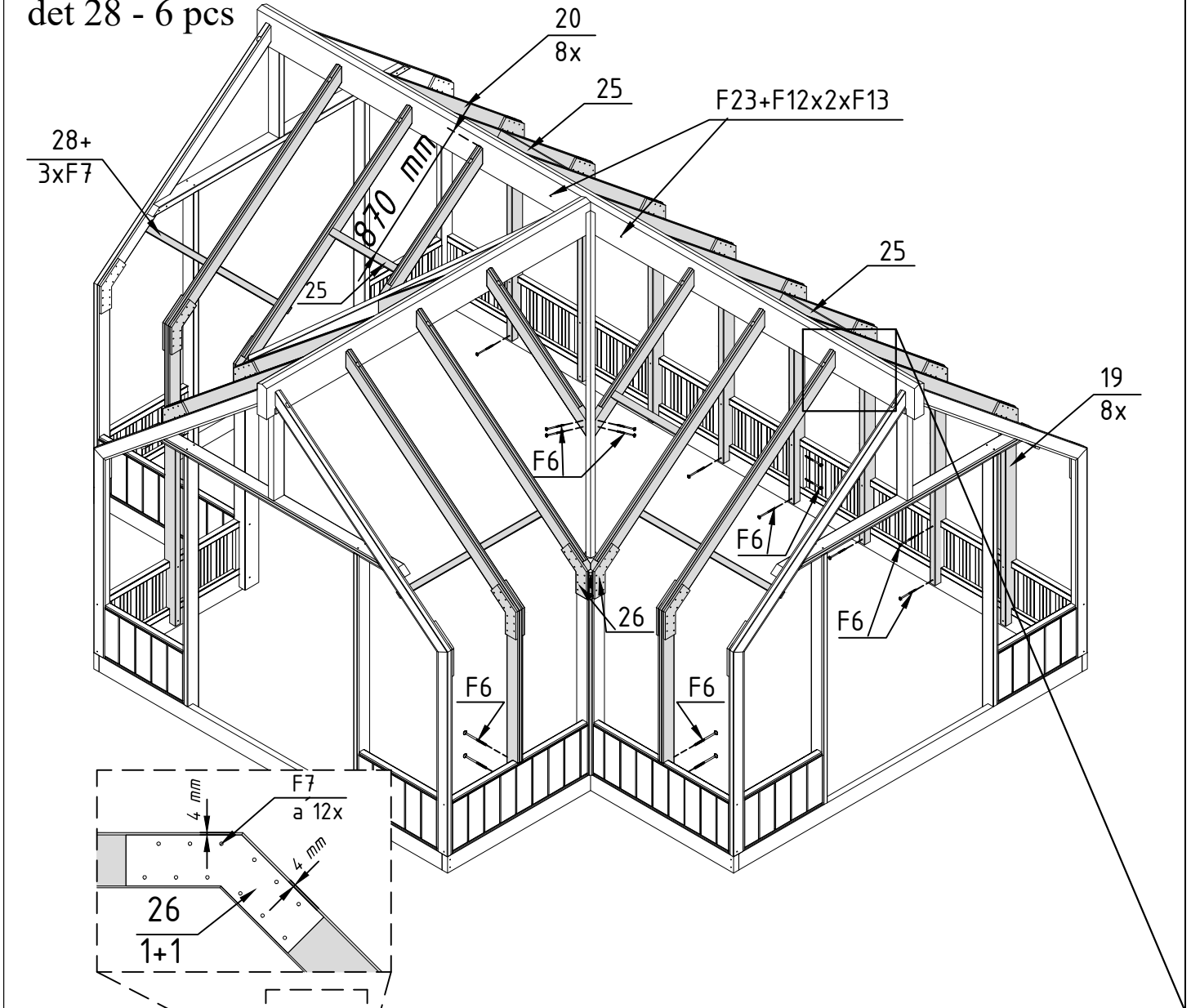

- F8 - 26 pcs
- F14 - 3 pcs
- F15a - 1 pcs
- F15b - 1 pcs
- F26 - 2pcs
- F30 - 8pcs

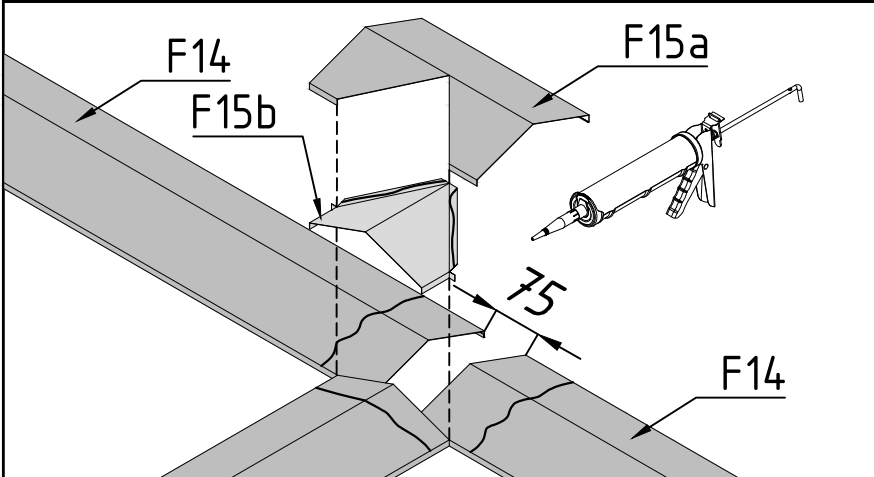
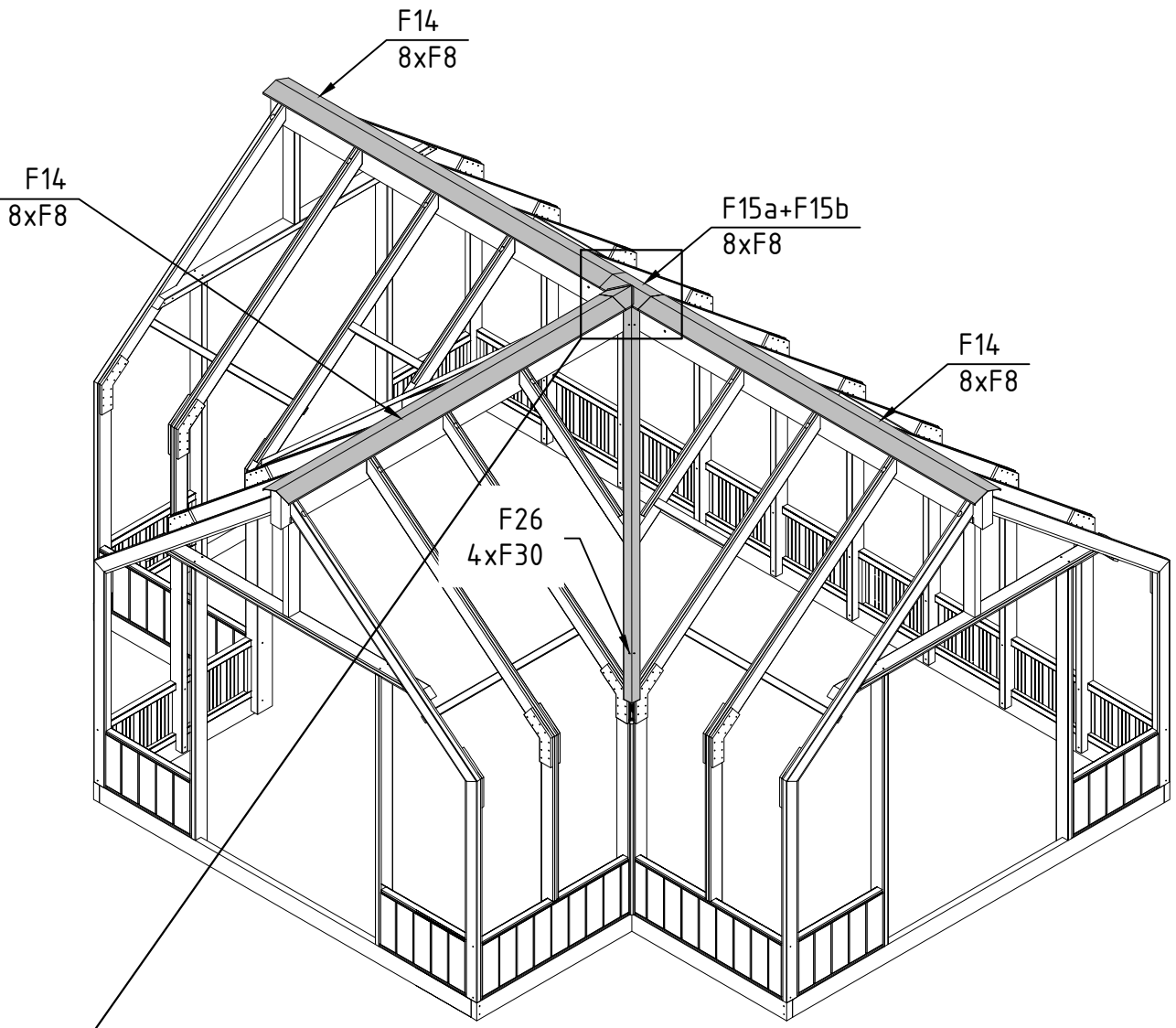

det 402 - 13 pcs  
det 411 - 4 pcs  
det 29 - 18 pcs  
det 41 - 2 pcs

F3 - 18 pcs  
F8 - 100 pcs  
F20 - 18 pcs 

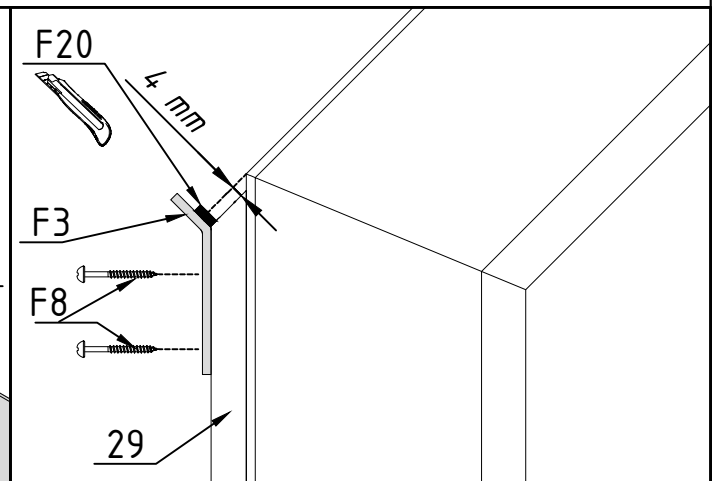
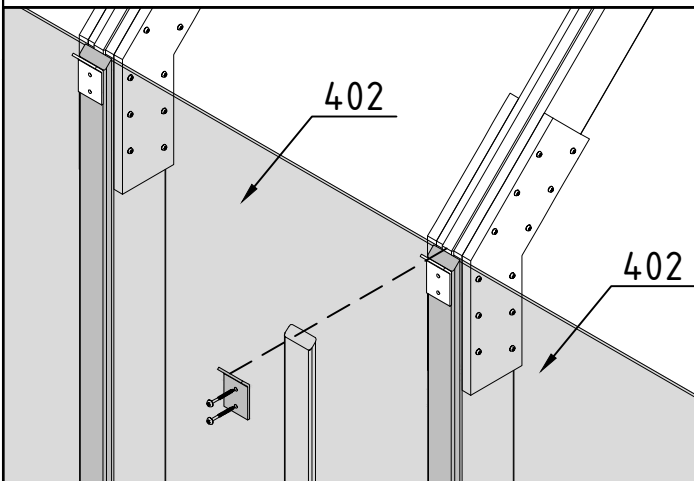
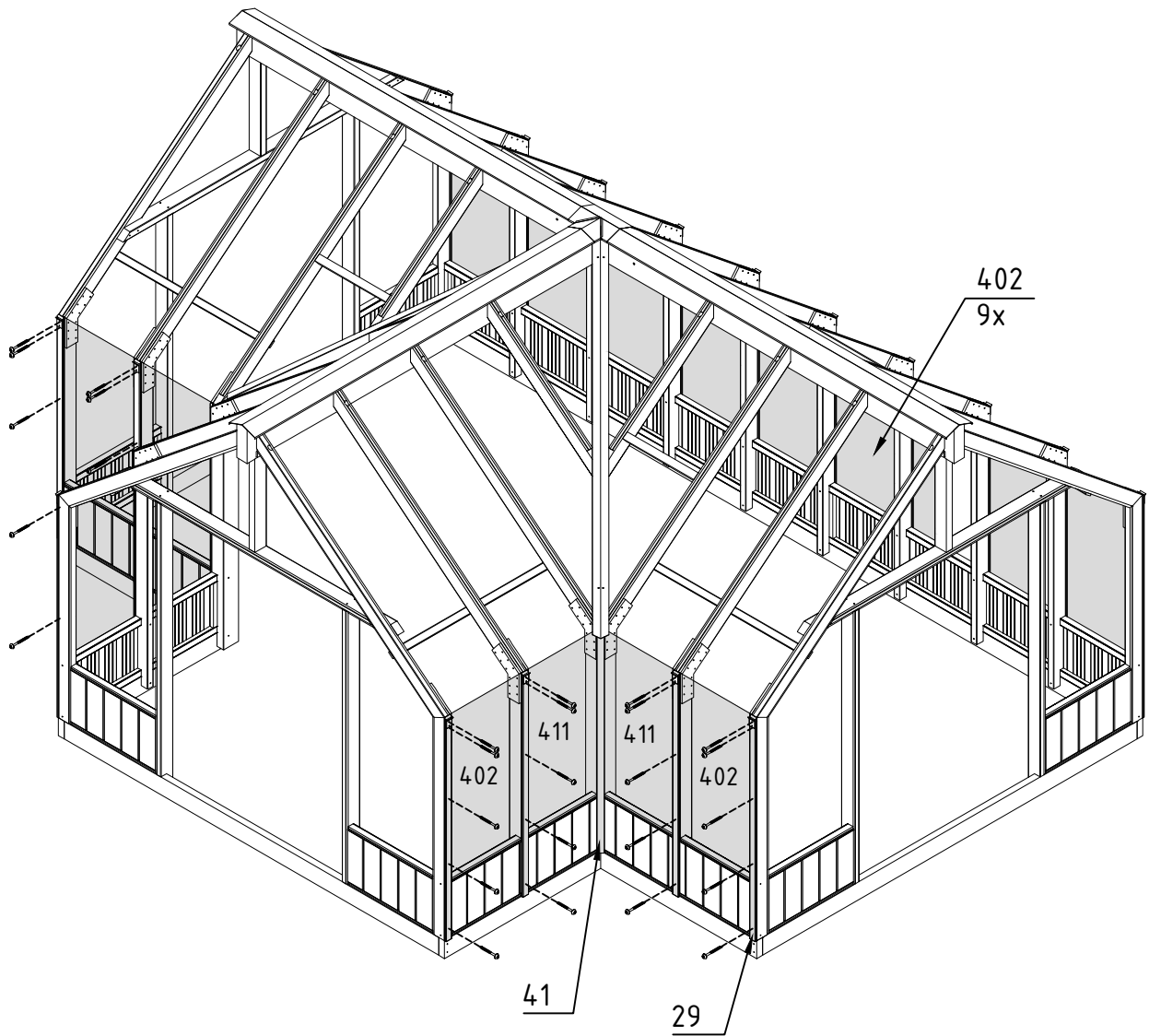

det 406 - 2 pcs  
det 408 - 4 pcs  
det 409 - 2 pcs  
det 31 - 2 pcs  
det 32 - 2 pcs  
det 33 - 2 pcs  
det 34 - 2 pcs

F8- 24 pcs

9

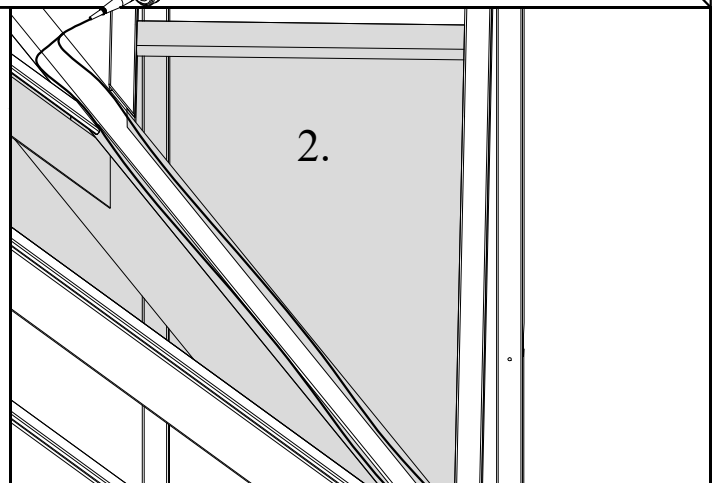
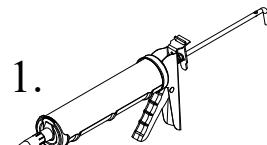
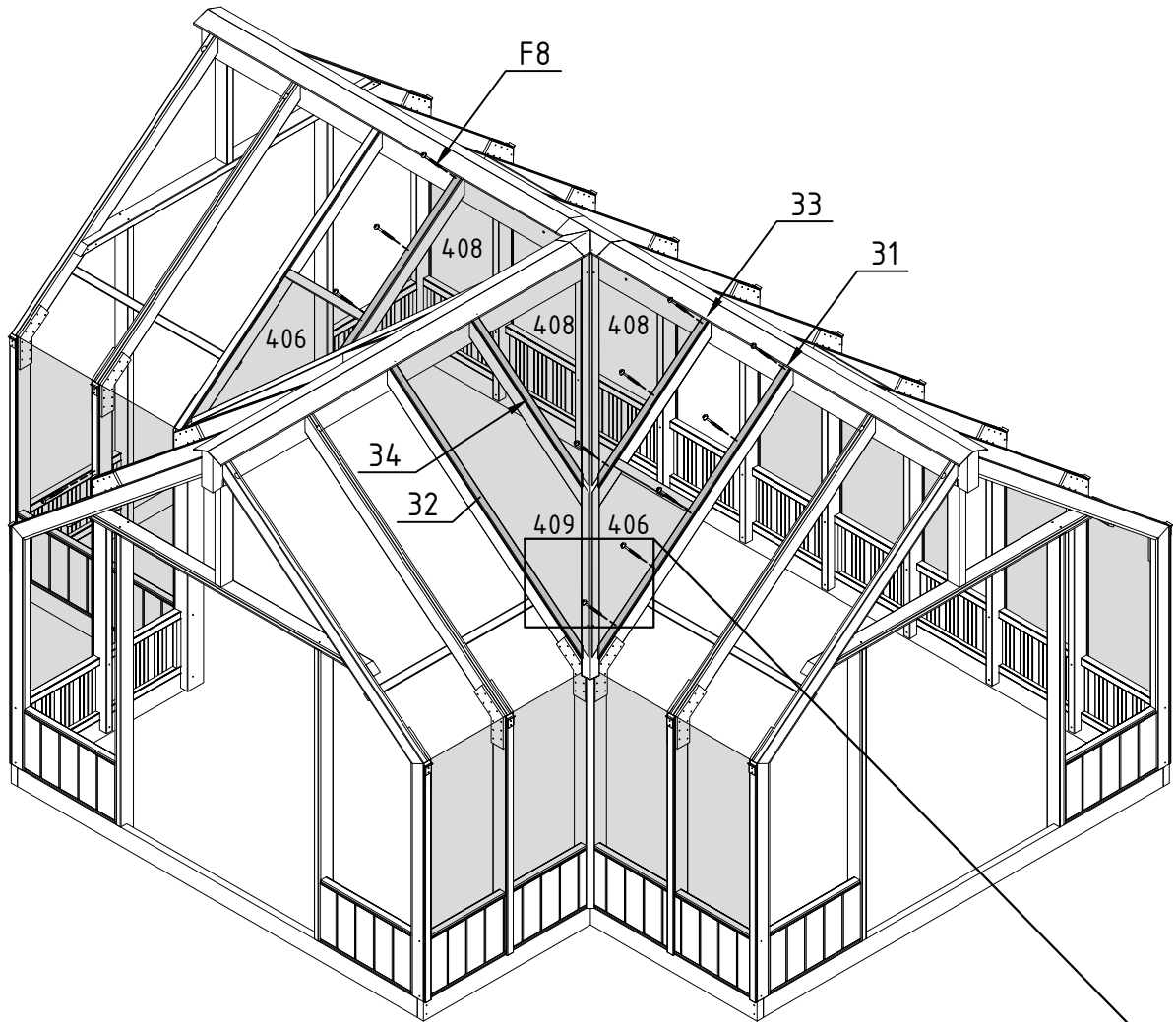

det 401 - 11 pcs  
det 403 - 2 pcs  
det 404 - 4 pcs  
det 30 - 18 pcs  
F8 - 90 pcs

F1 - 4 pcs  
F2 - 8 pcs

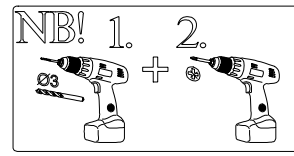

10

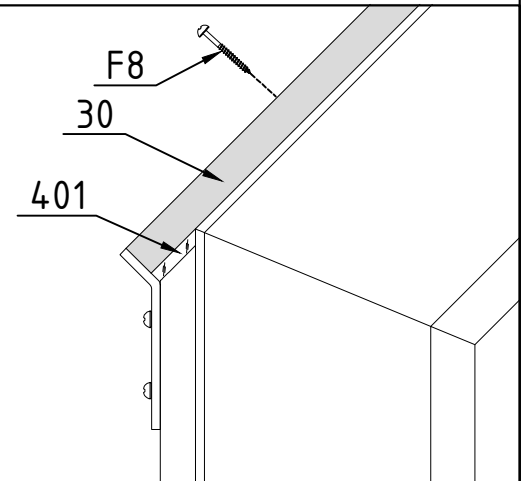
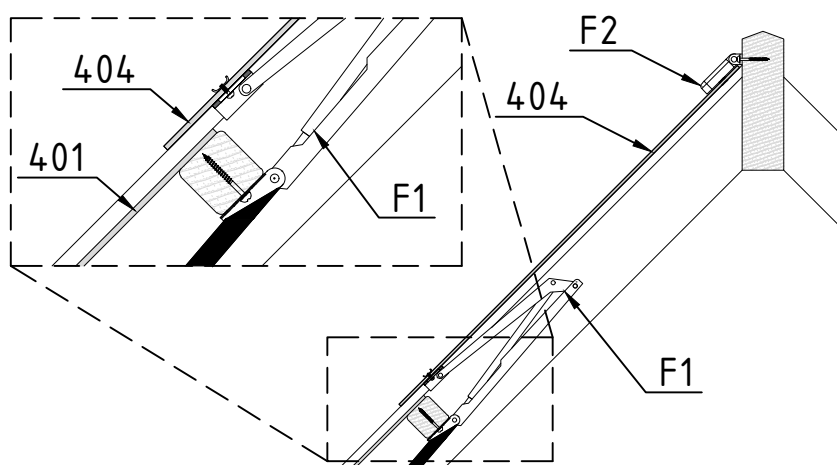
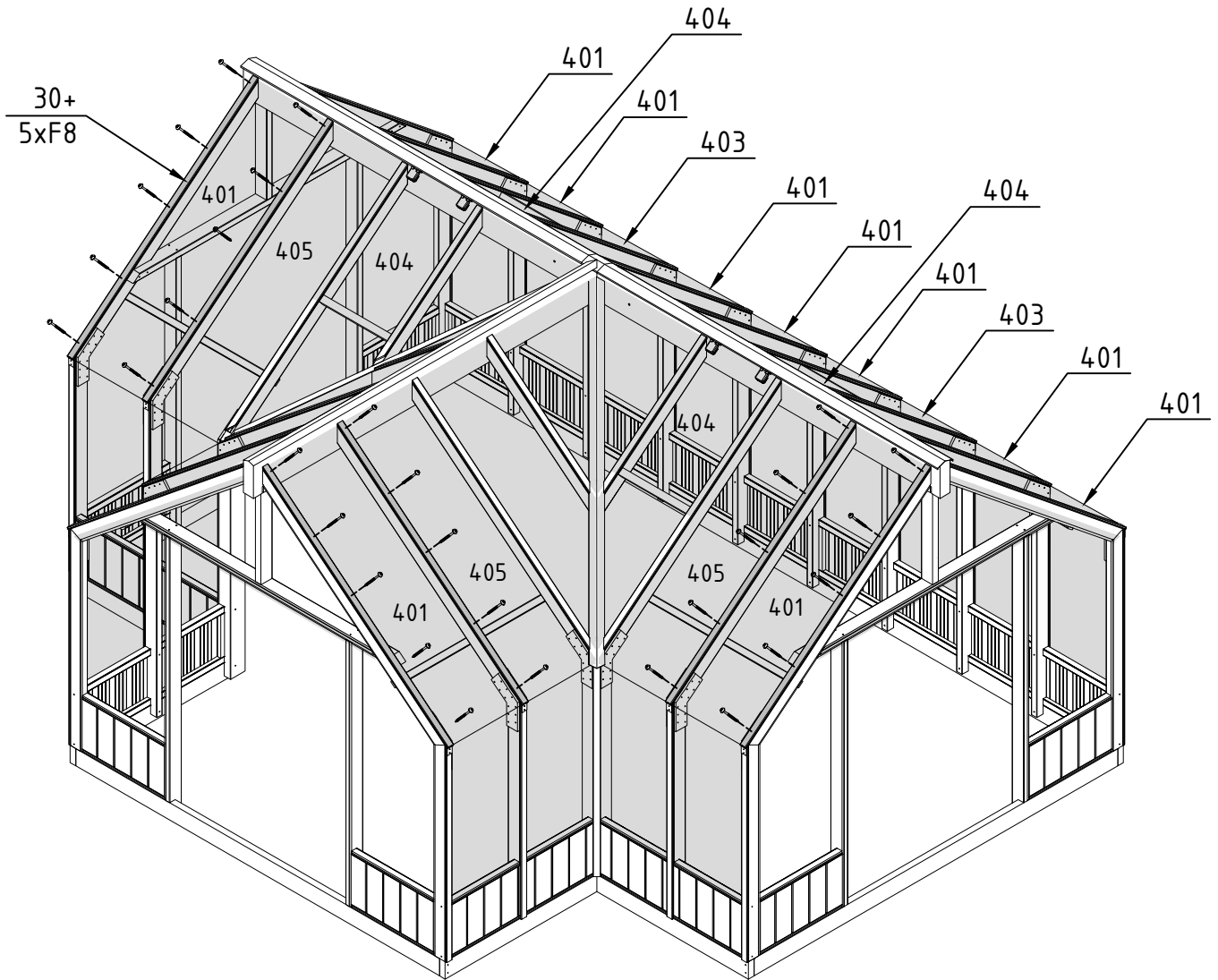

F2

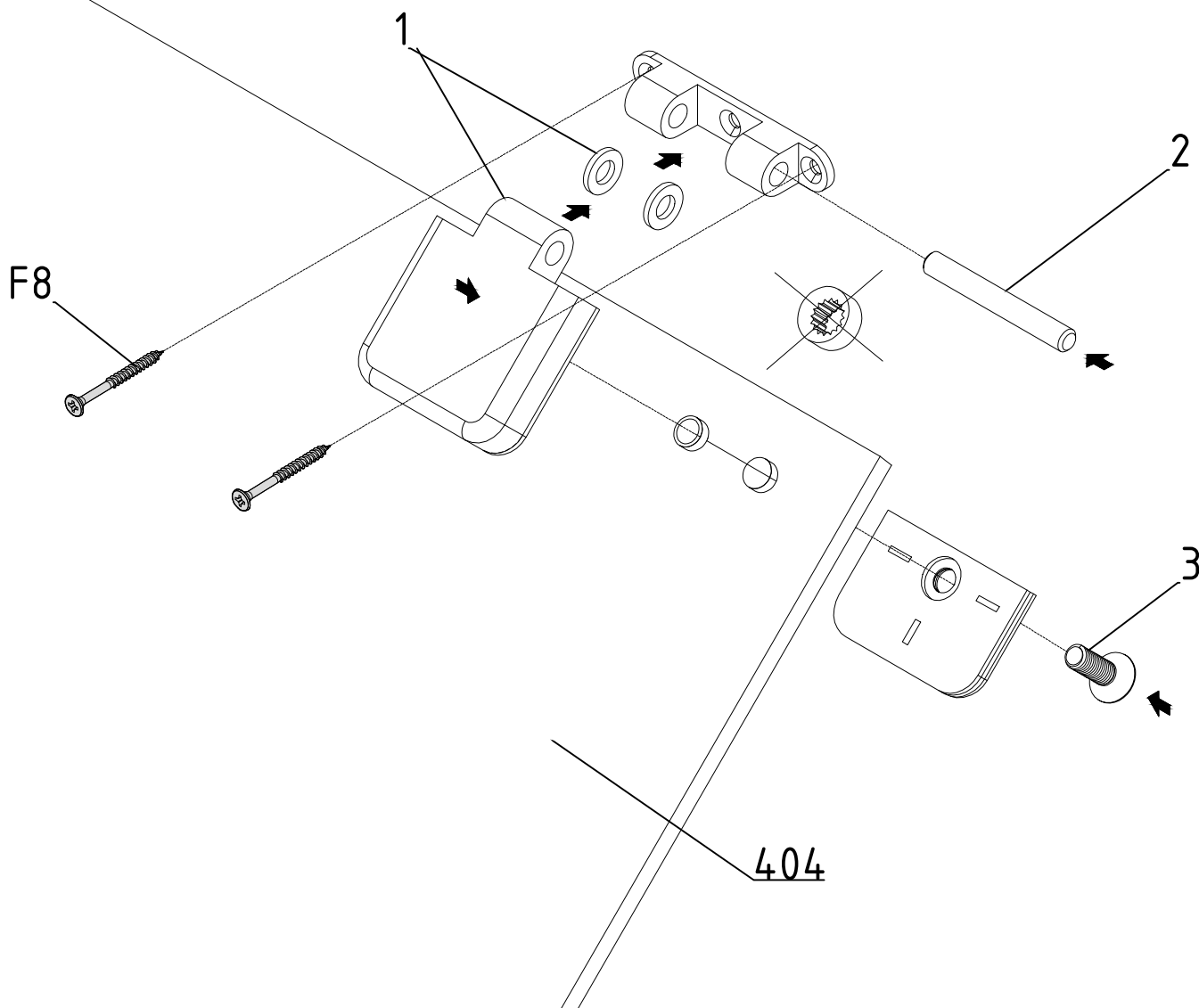

det 407 - 3 pcs  
det 412 - 6 pcs  
det 35 - 3 pcs  
det 37 - 12 pcs  
det 38 - 6 pcs  
det 39 - 6 pcs  
det 40 - 6 pcs  
F8 - 165 pcs

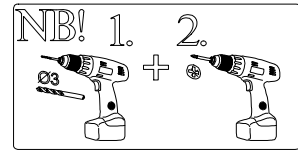

11

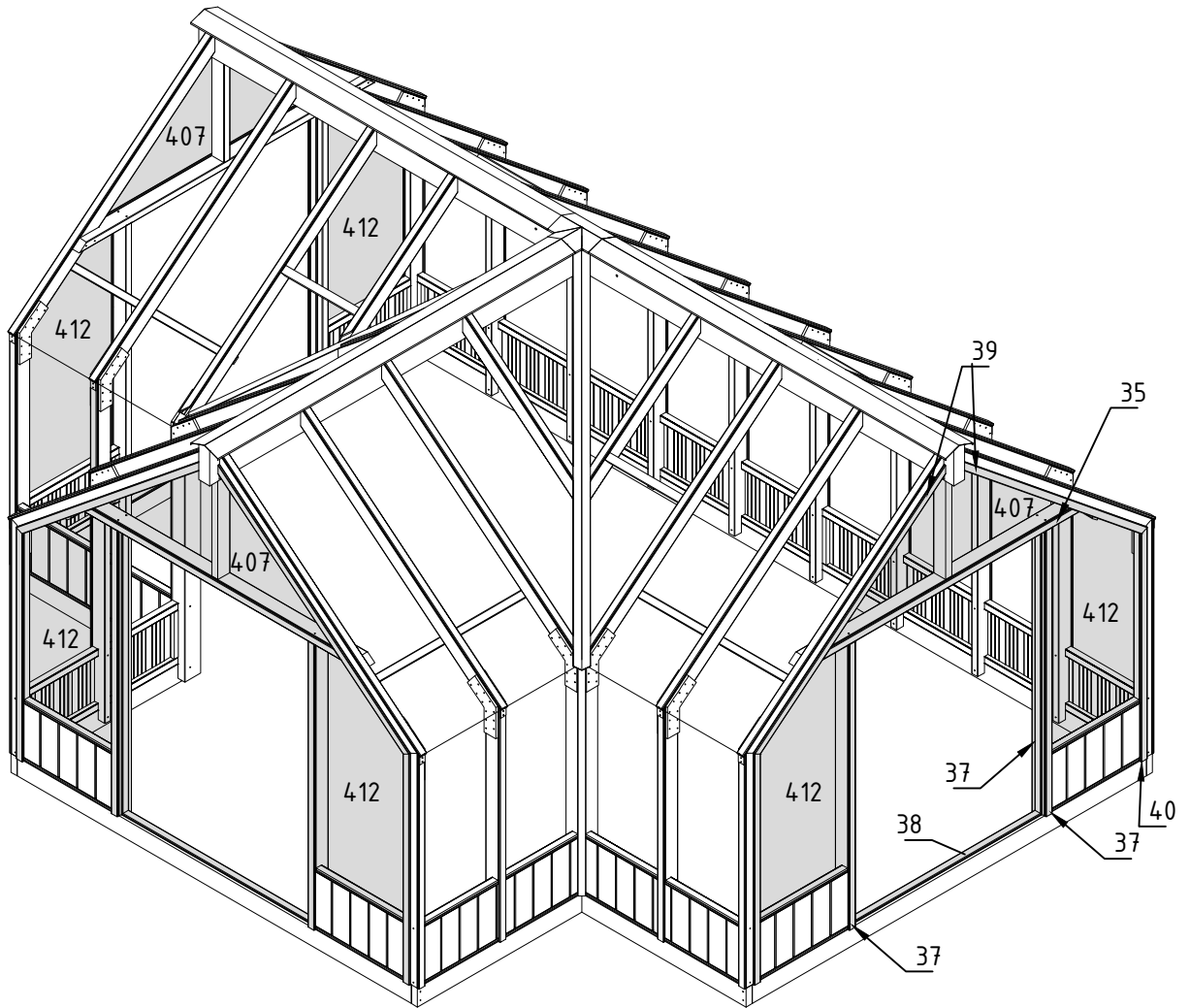

KUL-145 - 3 pcs  
KUL-145-2 - 3 pcs

F4 - 12 pcs  
F9 - 24 pcs  
F10 - 52 pcs  
F16 - 6 pcs  
F17 - 3 pcs  
F18 - 3 pcs  
F19 - 3 pcs  
F21 - 6 pcs  
F22 - 48 pcs

